



NO CARRIAGE BOLTS

ACCOMACK COUNTY

DECKS, PORCHES, STAIRS AND RAMPS

2012 VIRGINIA RESIDENTIAL CODE

- I agree to design and build the proposed deck in accordance with the Accomack County Building Deck Guide, which incorporates the 2012 Virginia Residential Code Section R507. Any structural element not prescribed in R507 shall be designed in accordance with an accepted engineering practice and sealed by a Registered Design Professional, licensed in Virginia.
- In accordance with the USBC 112.2, I agree to design and build the proposed deck with the American Wood Council DCA-6 (2012) Deck Guide and full compliance with the document is required.

Signature _____

DIRECTIONS

ACCOMACK COUNTY DEPARTMENT OF BUILDING HAS PREPARED THIS GUIDE FOR THE DESIGN OF BASIC DECKS, PORCHES, STAIRS AND RAMPS. IF A SPA, HOT TUB OR OTHER SPECIAL USE IS INTENDED, SEEK THE HELP OF A REGISTERED DESIGN PROFESSIONAL.

THIS DECK GUIDE IS BASED ON THE PRESCRIPTIVE REQUIREMENTS OF THE 2012 VIRGINIA RESIDENTIAL CODE.

THE FOLLOWING CONSTRUCTION DRAWINGS ARE REQUIRED:

1. 3 COPIES OF THE PLAT PLAN, SHOWING THE PROPOSED DECK LOCATION W/ DIMENSIONS.
2. 2 COPIES OF THE DECK PLANS, SPECIFICATION SHEETS AND DETAILS. THE FOLLOWING INSPECTIONS WILL BE REQUIRED:
 1. FOOTING INSPECTION PRIOR TO THE PLACEMENT OF CONCRETE.
 2. FRAMING INSPECTION
 3. FINAL INSPECTION

NOTE: THE FRAMING AND THE FINAL CAN BE COMBINED IF THE INSPECTOR IS ABLE TO ACCESS THE UNDERSIDE OF THE DECK.

GENERAL REQUIREMENTS

1. DECK FRAMING IS BASED ON 40 LBS PER SQ FT LIVE LOAD AND 10 LBS PER SQUARE FOOT DEAD LOAD. A PORCH ROOF IS BASED ON 20 LBS PER SQ FT SNOW LOAD AND 10 LBS PER SQ FT DEAD LOAD.
2. ALL DECK MATERIALS SHALL BE PRESERVATIVE TREATED (P.T.) LUMBER OR A COMPOSITE MATERIAL DESIGNED FOR DECKS. OUTSIDE USE AND SUITABLE FOR CONTACT WITH THE GROUND ALL CUT MATERIALS SHALL HAVE THEIR ENDS TREATED WITH AN APPROVED PRESERVATIVE, SUCH AS COPPER NAPHTHENATE.
3. TO RESIST CORROSION, THE FOLLOWING IS REQUIRED:
 - ALL SCREWS, BOLTS, NAILS AND FASTENERS SHALL BE HOT-DIPPED GALVANIZED (ASTMA-153 OR B-695, CLASS 55) OR STAINLESS STEEL.
4. FLASHING SHALL BE A MINIMUM 19 MIL THICK CORROSION-RESISTANT METAL OR AN APPROVED NON-METALLIC MATERIAL.
5. DO NOT ATTACH A LEDGER BOARD THROUGH BRICK VENEER OR TO A TRAILER OR MOBILE HOME.
6. DO NOT CONSTRUCT THE FOOTINGS OVER UTILITY LINES. CALL MISS UTILITY AT 811 BEFORE YOU START.
7. JCC DOES NOT ALLOW "ON-GRADE DECK BLOCKS" TO BE USED. (TAPERED CONCRETE BLOCKS WITH RECESSES FOR STRUCTURAL MEMBERS, THAT ARE TO BE USED ON TOP OF THE SOIL)

HOW TO USE THIS GUIDE

1. DECIDE ON THE APPROXIMATE DIMENSIONS AND LOCATION OF THE DECK OR PORCH.
2. DECIDE ON THE FRAMING STYLE: FREE-STANDING, LEDGER, CANTILEVERED, ETC.
3. COMPLETE THE LIST OF MATERIALS AND SIZES TO BE USED ON THE DECK SPECIFICATION SHEET.
4. DRAW THE PROPOSED DECK LOCATION ON YOUR PLAT PLAN. THE PLAT SHOULD SHOW THE EXISTING LOCATION OF YOUR HOME, ALL ACCESSORY STRUCTURES AND/OR DRAIN FIELDS & WELLS. PROVIDE APPROXIMATE DISTANCES FROM THE DECK TO THE PROPERTY LINES.
5. USE THE ATTACHED DETAILS FOR OTHER ASPECTS OF THE CONSTRUCTION.

STANDARD ABBREVIATIONS

HDG – HOT DIPPED GALVANIZED (ASTM A-153 OR B695, CLASS 55) O.C. – ON CENTER

P.T. – PRESERVATIVE TREATED

DECK SPECIFICATION SHEET

(Please fill out and attach a drawing of the proposed deck.)

1. Free Standing / Ledger Deck / Cantilever (please circle)
 2. Deck Dimensions (L x W): _____ x _____ (Height)
 3. Lumber Species: Southern Pine or Alt. _____
 4. Footing Dimensions (L x W): _____ x _____ (Thick), _____ (Deep)
Total #: _____ (Incl. Stairs)
 5. Post Size (L x W): _____ x _____ Post Spacing : _____
 6. Post Base/Cap Connectors: _____
Yes _____
- No. 12" Embedment in Concrete or Soil & Post Must be Notched (6x6 Only)
7. Ledger (L x W): _____ x _____ w/ 1/2" dia. Bolts/Lag Screws
 8. Beams (L x W): () - _____ x _____
 9. Joist (L x W): _____ x _____ @ _____ o.c.
 10. Wood plastic/Composites: ICC Report and Manufacturers Installation Instructions provided: Y N

DECK TYPES

Free-Standing Deck: a self-supporting deck structure built independently from a house, requiring at least two support beams.

Ledger Deck: a deck structure that is physically attached to the house with a ledger board, eliminating the need for a beam or footings adjacent to the house. **Note: not all decks can use attachment with a ledger board due to the exterior surface and/or the shape of the home's exterior wall **

NO CARRIAGE BOLTS

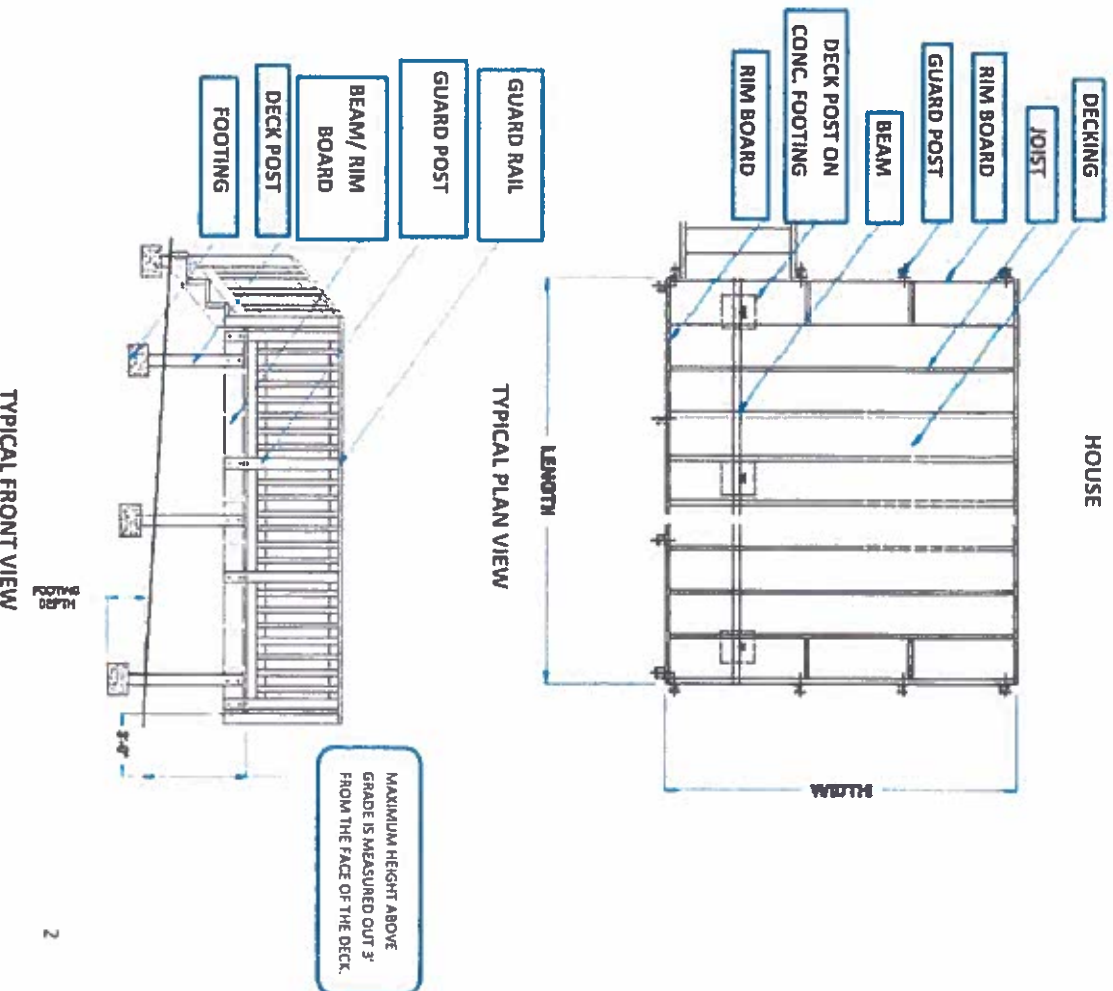

PORCH SPECIFICATION SHEET

(Please fill out and attach a drawing of the proposed deck.)

1. Is the porch to be constructed on new footings? Y N
2. Is a roof being added to an existing deck? Y N
3. Is it going to be a screened porch? Y N
4. Roof Support Posts: Post Size _____ x _____ Post Spacing _____ FT
5. Rafter Support Beam (_____) _____ x _____
6. Rafters _____ x _____ @ _____ o.c.
7. Ceiling (If Provided) Joist Size _____ x _____ @ _____ o.c.

MINIMUM RAFTER SUPPORT BEAM

POST SPACING (FT)	RAFTER SPAN (FT)	6	8	10	12	14	16
4	(1) 2x6	(1) 2x6	(1) 2x6	(1) 2x6	(1) 2x6	(1) 2x6	(1) 2x6
5	(1) 2x6	(1) 2x6	(1) 2x6	(1) 2x6	(1) 2x6	(1) 2x6	(1) 2x6
6	(1) 2x6	(1) 2x6	(1) 2x6	(1) 2x6	(1) 2x6	(1) 2x6	(1) 2x6
7	(1) 2x6	(1) 2x6	(1) 2x6	(1) 2x6	(1) 2x6	(1) 2x6	(1) 2x6
8	(1) 2x6	(1) 2x6	(1) 2x6	(1) 2x6	(1) 2x6	(1) 2x6	(1) 2x6
9	(1) 2x6	(1) 2x6	(1) 2x6	(1) 2x6	(1) 2x6	(1) 2x6	(1) 2x6
10	(1) 2x6	(1) 2x6	(1) 2x6	(1) 2x6	(1) 2x6	(1) 2x6	(1) 2x6
11	(1) 2x6	(1) 2x6	(1) 2x6	(1) 2x6	(1) 2x6	(1) 2x6	(1) 2x6
12	(1) 2x6	(1) 2x6	(1) 2x6	(1) 2x6	(1) 2x6	(1) 2x6	(1) 2x6

MAXIMUM RAFTER SPANS

SIZE	RAFTER SPACING (O.C.)	MAX RAFTER SPANS W/ CEILING JOISTS	MAX RAFTER SPANS W/ O CEILING JOISTS
2x4	12"	6'-6"	10'-0"
	15"	8'-1"	9'-0"
	24"	7'-4"	7'-4"
2x6	12"	8'-0"	12'-6"
	15"	10'-5"	15'-2"
	24"	11'-0"	11'-0"
2x8	12"	10'-6"	15'-8"
	15"	12'-1"	17'-5"
	24"	13'-11"	13'-11"
2x10	12"	10'-5"	13'-5"
	15"	10'-6"	16'-0"
	24"	10'-6"	16'-0"
2x12	12"	10'-6"	16'-0"
	15"	14'-10"	18'-10"
	24"	14'-6"	18'-6"

BASED ON THE 2012 V-LINE SPAN TABLES FOR SOUTHERN PINE #2, FOR OTHER SPECIES REFER TO THE CODE BOOK. ASSUMES 20 PSF GROUND SNOW LOAD AND 10 PSF DEAD LOAD.

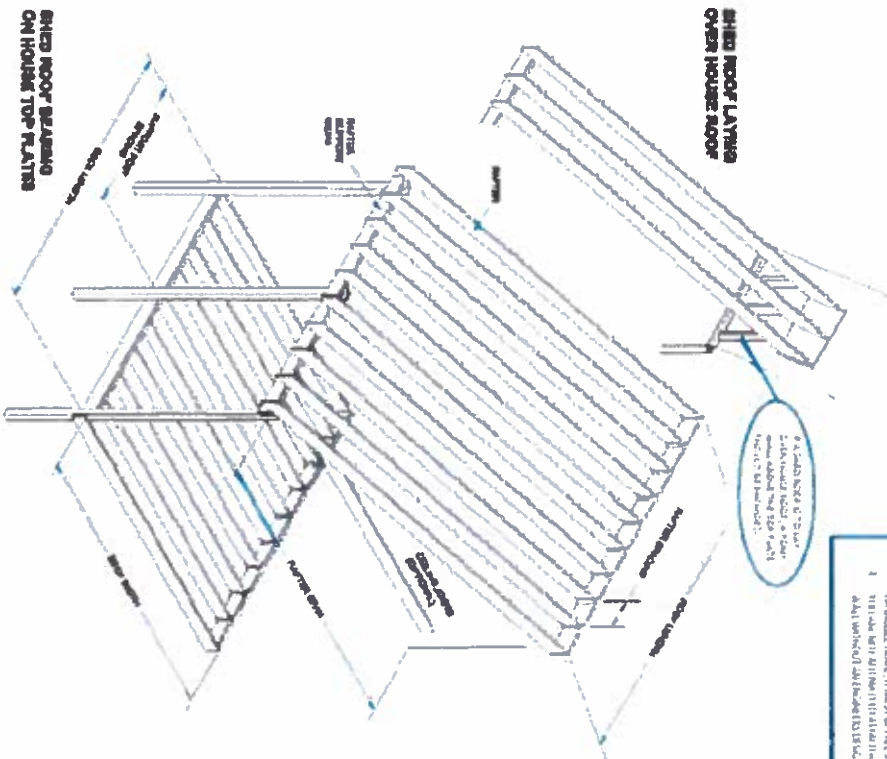

1. DO NOT SIGN/DRAW/STAMP UNTIL ALL REQUIREMENTS ARE MET.
2. THIS DRAWING IS THE PROPERTY OF THE ARCHITECT AND IS NOT TO BE REPRODUCED OR COPIED WITHOUT THE ARCHITECT'S WRITTEN PERMISSION.
3. THE ARCHITECT IS NOT RESPONSIBLE FOR THE ACCURACY OF THE INFORMATION PROVIDED BY THE CLIENT.
4. THE ARCHITECT IS NOT RESPONSIBLE FOR THE ACCURACY OF THE INFORMATION PROVIDED BY THE CLIENT.
5. THE ARCHITECT IS NOT RESPONSIBLE FOR THE ACCURACY OF THE INFORMATION PROVIDED BY THE CLIENT.
6. THE ARCHITECT IS NOT RESPONSIBLE FOR THE ACCURACY OF THE INFORMATION PROVIDED BY THE CLIENT.
7. THE ARCHITECT IS NOT RESPONSIBLE FOR THE ACCURACY OF THE INFORMATION PROVIDED BY THE CLIENT.
8. THE ARCHITECT IS NOT RESPONSIBLE FOR THE ACCURACY OF THE INFORMATION PROVIDED BY THE CLIENT.
9. THE ARCHITECT IS NOT RESPONSIBLE FOR THE ACCURACY OF THE INFORMATION PROVIDED BY THE CLIENT.
10. THE ARCHITECT IS NOT RESPONSIBLE FOR THE ACCURACY OF THE INFORMATION PROVIDED BY THE CLIENT.

MEMBER SIZING

JOISTS

THE SPAN OF THE JOIST IS MEASURED FROM THE CENTERLINE OF BEARING AT ONE END OF THE JOIST TO THE CENTERLINE OF BEARING AT THE OTHER END OF THE JOIST AND DOES NOT INCLUDE THE LENGTH OF THE OVERHANGS (CANTILEVERS).

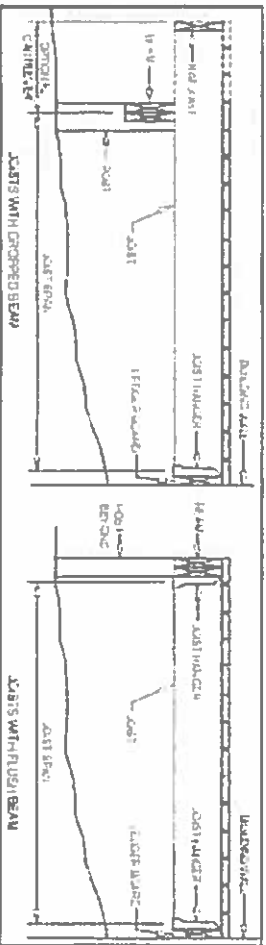

MAXIMUM DECK JOIST SPANS

SPECIES ^b	SIZE	ALLOWABLE JOIST SPAN ^c		ALLOWABLE CANTILEVER ^{d,e}	
		Spacing of deck joists (inches)		Spacing of deck joists (inches)	
Southern pine	2 X 6	9-11	9-0	7-7	1-3
	2 X 8	13-1	11-10	9-8	2-1
	2 X 10	16-2	14-0	11-5	3-4
	2 X 12	18-0	16-6	13-6	4-6

^a Spans and cantilevers are given in feet and inches.
^b No. 2 grade with wet service factor.
^c Ground snow load, live load = 40 psf, dead load = 10 psf; U/L = 360 at main span, U/L = 180 at cantilever with a 220 pound point load applied to end.
^d Ground snow load, live load = 40 psf, dead load = 10 psf; U/L = 360 at main span, U/L = 180 at cantilever with a 220 pound point load applied to end.
^e Maximum allowable cantilever that not exceed one-fourth of the actual joist span. Recommended cantilever length is 2' max.
^f Includes racking factor.
^g Medium species with no racking factor.

DECKING BOARDS

1. DECKING BOARDS ARE TYPICALLY 2X6, 5/4 P.T. BOARDS OR A COMPOSITE MATERIAL. COMPOSITE DECKING SHALL BE INSTALLED IN ACCORDANCE WITH THE MANUFACTURER'S INSTRUCTIONS. **MUST BE PROVIDED**
2. ATTACH DECKING BOARDS TO DECK JOISTS WITH 2-8d HDG NAILS, (2) #8 SCREWS OR PROPRIETARY FASTENERS INTENDED FOR P.T. WOOD.
3. DECK BOARDS SHALL BE SPACED APPROXIMATELY 1/8" APART (EDGE TO EDGE).
4. DECKING MAY BE APPLIED DIAGONALLY IF JOISTS ARE SPACED A MAXIMUM OF 16" O.C.
5. EACH PIECE OF DECKING MUST BEAR ON AT LEAST 3 JOISTS.

MATERIAL TYPE AND NOMINAL SIZE	MAXIMUM JOIST SPACING PERPENDICULAR TO JOIST	DIAGONAL TO JOIST*
3/4-inch thick wood	16	12
2-inch thick wood	24	16
Wood/plastic composite	Per R507.3	Per R507.3

DECK POSTS

1. DECK POSTS OVER 4' IN HEIGHT SHALL BE DIAGONALLY BRACED.
2. DECK POSTS MAY BE EITHER P.T WOOD OR MASONRY.

MAXIMUM DECK POST HEIGHTS

DECK POST SIZE	MAXIMUM HEIGHT ^a
4X4	8
4X6	8
6X6	14

^a For 6x1 post = 25.4 mm, 1 post = 324.8 mm.
^b Measured to the underside of the beam.

BEAMS

1. BEAMS SUPPORT THE DECK JOISTS. THE JOISTS EITHER BEAR ON TOP OF THE BEAM FOR A CANTILEVER DESIGN, OR ARE HUNG FLUSH ALONG SIDE OF IT WITH MECHANICAL HANGERS.
2. TWO OR THREE MEMBERS MAY BE CONNECTED TOGETHER TO FORM THE BEAM USING 10d HDG NAILS OR #10 SHDG SCREWS, STAGGERED IN TWO ROWS, AT 16" O.C.
3. WHENEVER FOUR OR MORE MEMBERS ARE USED, THEY SHOULD BE BOLTED TOGETHER WITH ½" HDG THROUGH-BOLTS AT 24" O.C.
4. THE ENDS OF EACH JOIST AND BEAM SHALL HAVE NOT LESS THAN 1.5 INCHES OF BEARING ON WOOD OR METAL AND NOT LESS THAN 3 INCHES ON CONCRETE OR MASONRY FOR THE ENTIRE WIDTH OF THE BEAM. JOIST FRAMING INTO THE SIDE OF A LEDGER BOARD OR BEAM SHALL BE SUPPORTED BY APPROVED JOIST HANGERS. JOISTS BEARING ON A BEAM SHALL BE ATTACHED TO THE BEAM TO RESIST LATERAL DISPLACEMENT.

TYPICAL DECK BEAM SPANS

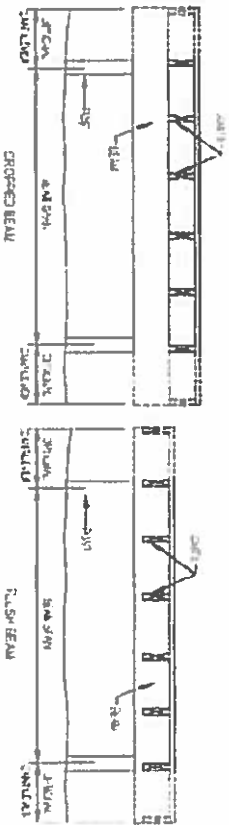

OPTIONAL CANTILEVER, MAX LENGTH EQUALS BEAM SPAN L/4.

DECK BEAM SPAN^a LENGTHS^{b,c}

SPECIES ^d	SIZE ^e	DECK JOIST SPAN (feet) LESS THAN OR EQUAL TO:																
		6	8	10	12	14	16	18	20	22	24	26	28	30	32	34	36	
Southern pine	2-2x6	6-11	5-11	5-4	4-10	4-6	4-3	4-0										
	2-2x8	8-9	7-7	6-9	6-2	5-9	5-4	5-0										
	2-2x10	10-4	9-0	8-0	7-4	6-9	6-4	6-0										
	2-2x12	12-2	10-7	9-5	8-7	8-0	7-6	7-0										
	3-2x6	8-2	7-5	6-8	6-1	5-8	5-3	5-0										
	3-2x8	10-10	9-6	8-6	7-9	7-2	6-8	6-4										
	3-2x10	13-0	11-3	10-0	9-2	8-6	7-11	7-6										
	3-2x12	15-3	13-3	11-10	10-9	10-0	9-4	8-10										

- For S15, 1 inch = 25.4 mm, 1 foot = 304.8 mm
- ^a Spans in green or bear and inches
- ^b Ground snow load: low load = 40 psf, med load = 10 psf, U/A = 350 at main span, U/A = 180 at cantilever, with a 220 psf wind perc load applied at the end
- ^c Beams supporting deck joists from one side only
- ^d No. 2 grade, wet service factor
- ^e Beams open to the greater, than or equal to depth of joists with a flush beam condition
- ^f Includes recovery factor
- ^g Footings spaced with no encasing back

FOOTINGS

1. ALL FOOTINGS SHOULD BEAR ON UNDISTURBED SOIL AT LEAST 12" BELOW THE FINISHED GRADE.
2. IF THE FOOTING IS WITHIN 5' OF THE EXISTING HOUSE FOOTING, IT SHALL BE AT THE SAME DEPTH AS THE HOUSE FOOTING.



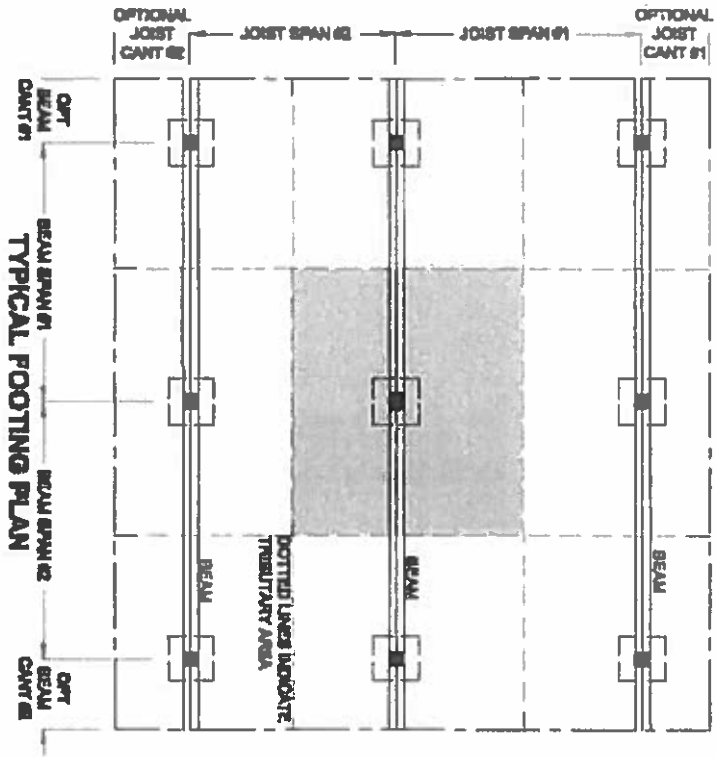

MATHEMATICAL EXAMPLE:
 90 SQ. FT. (TRIBUTARY AREA) X 50 PSF (TOTAL DESIGN LOAD) = 4,500 LBS.
 4,500 LBS. / 1,500 PSF (SOIL) = 3 SQ. FT. 3 SQ. FT. X 144 SQ. IN = 432 SQ. IN
 SQUARE ROOT OF 432 = 20.78" (FOOTING SIZE)

FOOTING SIZE CHART

TRIBUTARY AREA (SQ. FT.)	FOOTING DIMENSION SQUARE (INCHES)	FOOTING DIAMETER ROUND (INCHES)	THICKNESS (INCHES)
20	12	14	8
30	12	14	8
40	14	16	8
50	16	18	8
60	17	19	8
70	18	20	8
80	20	22	8
100	22	25	8
120	24	27	9
140	26	29	10
160	28	31	11

- MINIMUM SIZES FOR CONCRETE AND MASONRY FOOTINGS IS 12".
- SPREAD FOOTINGS SHALL BE AT LEAST 6 INCHES IN THICKNESS.
- FOOTING PROJECTIONS SHALL BE AT LEAST 2 INCHES AND SHALL NOT EXCEED THE THICKNESS OF THE FOOTING.
- THE LOAD-BEARING VALUE OF THE SOIL IS ASSUMED AT 1,500 PSF.
- THE FOOTING SIZES IN THIS TABLE ASSUME NO ROOF LOAD. IF THE FOOTING SUPPORTS A PORCH ROOF, ADD 4" TO THE DIMENSION IN THIS TABLE.
- INTERPOLATION IS PERMITTED.

CONNECTIONS

BEAM CONNECTION TO POST

1. DECK BEAMS SHALL BE ATTACHED TO DECK POSTS IN ACCORDANCE WITH THE FIGURE BELOW OR BY OTHER EQUIVALENT MEANS CAPABLE TO RESIST LATERAL DISPLACEMENT.
2. MANUFACTURED POST-TO-BEAM CONNECTORS SHALL BE SIZED FOR THE POST AND BEAM SIZES.
3. ALL BOLTS SHALL HAVE WASHERS UNDER THE HEAD AND NUT.

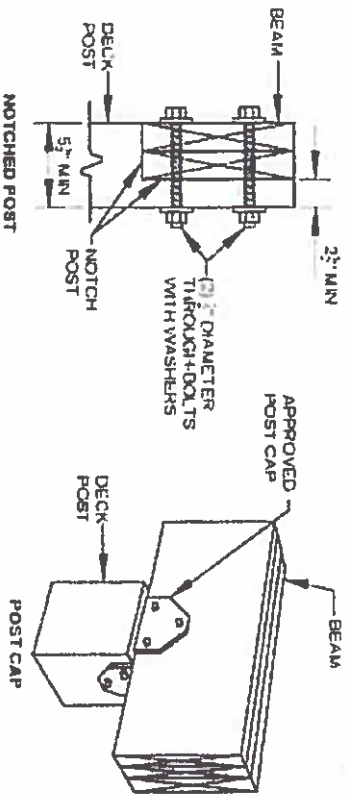

****4X4 POST CANNOT BE NOTCHED****

PROHIBITED CONNECTION

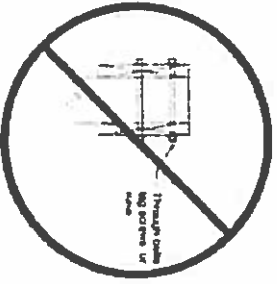

LEDGER BOARD CONNECTION TO HOUSE

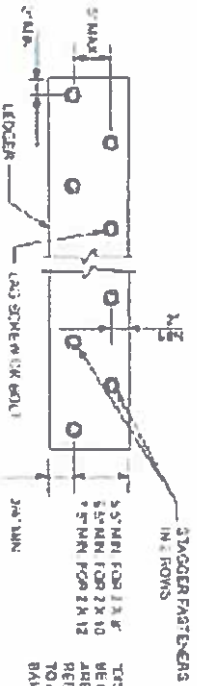
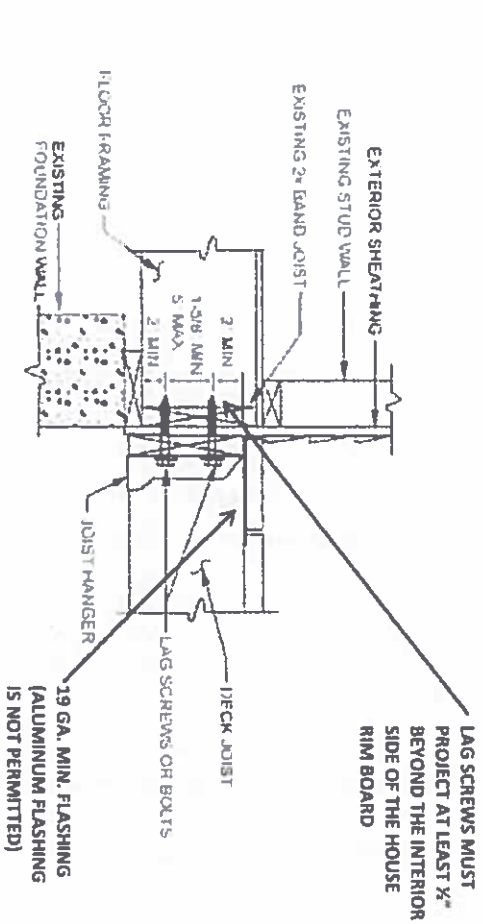

(SEE TABLE FOR FASTENER SPACING)

NO CARRIAGE BOLTS

ON-CENTER SPACING FOR FASTENERS ATTACHING DECK TO HOUSE

JOIST SPAN	On-center spacing of fasteners								
	6' and less	6'1" to 8'	8'1" to 10'	10'1" to 12'	12'1" to 14'	14'1" to 16'	16'1" to 18'	18'1" to 20'	20'1" to 24'
Connection details 1/2 inch diameter lag screw with 1/2 inch maximum sheathing	30	23	18	15	13	11	10		
1/2 inch diameter bolt with 1/2 inch maximum sheathing	36	36	34	29	24	21	19		
1/2 inch diameter bolt with 1 1/2 inch maximum sheathing and 1/2 inch stacked washers	36	36	29	24	21	18	16		

1. THE MAXIMUM GAP BETWEEN THE FACE OF THE LEDGER BOARD AND THE FACE OF THE HOUSE BAND JOIST SHALL BE 3/8".
2. THE TIP OF THE LAG SCREW SHALL FULLY EXTEND BEYOND THE INSIDE OF THE BAND JOIST (BOARD).
3. LEDGERS SHALL BE FLASHED TO PREVENT WATER FROM CONTACTING THE HOUSE BAND JOIST (BOARD).
4. LAG SCREWS AND BOLTS SHALL BE STAGGERED AND SHALL NOT BE CLOSER THAN 2" TO THE TOP AND BOTTOM OF THE LEDGER.
5. DECK LEDGERS SHALL BE 2X8 PRESERVATIVE TREATED SOUTHER PINE (MIN) OR OTHER APPROVED METHOD AND MATERIAL AS ESTABLISHED BY STANDARD ENGINEERING PRACTICE.
6. LAG SCREWS, BOLTS AND WASHERS SHALL BE HOT-DIPPED GALVANIZED OR STAINLESS STEEL.
7. GIRDERS SUPPORTING DECK JOISTS SHALL NOT BE SUPPORTED ON DECK LEDGERS OR BAND JOISTS. DECK LEDGERS SHALL NOT BE SUPPORTED ON STONE OR MASONRY VENEER.

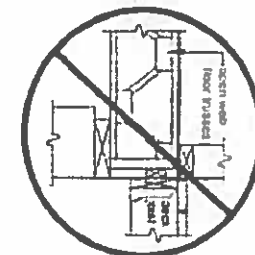
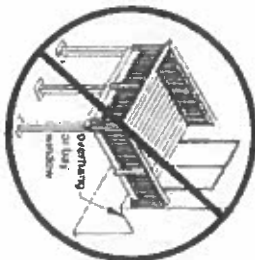
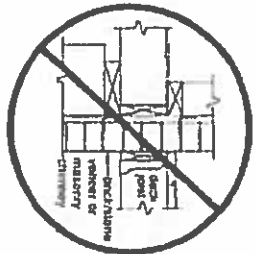

PROHIBITED CONNECTIONS

DECK ATTACHMENT FOR LATERAL LOADS

Lateral restraint at supports.

Joist ends and bearing locations shall be provided with lateral restraint to prevent rotation. Where lateral restraint is provided by joist hangers or blocking between joists, their depth shall equal not less than 60 percent of the joist depth. Where lateral restraint is provided by rim joists, they shall be secured to the end of each joist with a minimum of (3) 10d nails or (3) #10x3 inch long wood screws.

LATERAL SUPPORT:

All decks greater than 30" above grade must resist lateral load by using one of the methods below:

**OPTION 1: LEDGER DECKS
INTERIOR/EXTERIOR HOLD DOWN TENSION DEVICE**

(Approved tension-tie: Simpson DTT2Z)

1. HOLD-DOWN TENSION DEVICES SHALL BE INSTALLED IN NOT LESS THAN TWO LOCATIONS PER DECK.
2. EACH DEVICE SHALL HAVE AN ALLOWABLE STRESS DESIGN CAPACITY OF NOT LESS THAN 1500 POUNDS.

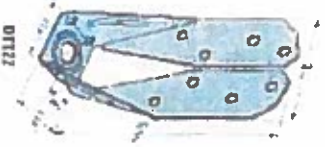
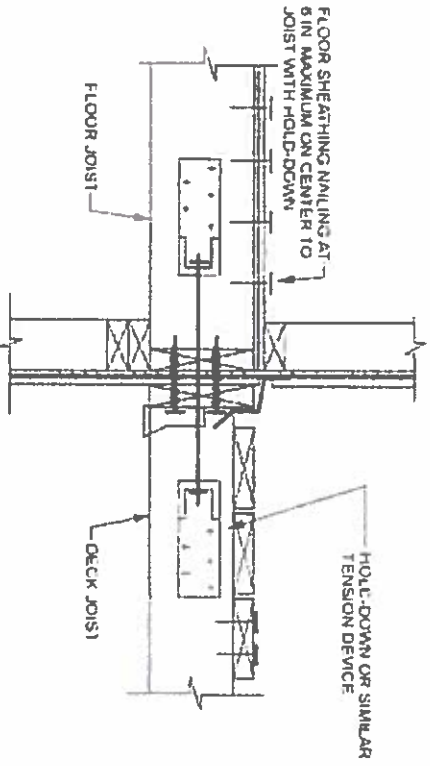

**OPTION #2: LEDGER DECKS
EXTERIOR HOLD DOWN TENSION DEVICE**

(Approved tension-tie: Simpson DTT1Z)

1. THIS METHOD IS ONLY PERMITTED WHERE THE DECK AND FLOOR JOISTS RUN PARALLEL.
2. HOLD-DOWN TENSION DEVICES SHALL BE INSTALLED IN NOT LESS THAN FOUR LOCATIONS PER DECK AS SHOWN BELOW.
3. TENSION DEVICE MUST BE INSTALLED PER MANUFACTURERS INSTALLATION INSTRUCTIONS.
4. EACH DEVICE SHALL HAVE AN ALLOWABLE STRESS DESIGN CAPACITY OF NOT LESS THAN 750 POUNDS.

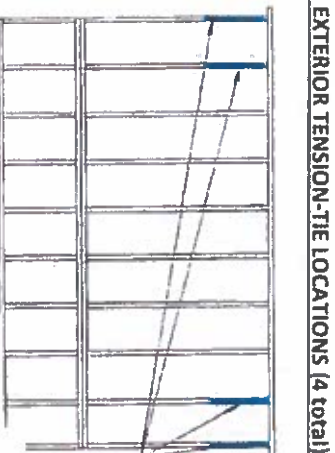

INSTALL TENSION-TIE TO UNDERSIDE OF OUTSIDE AND FIRST INSIDE JOISTS ON EACH SIDE OF DECK

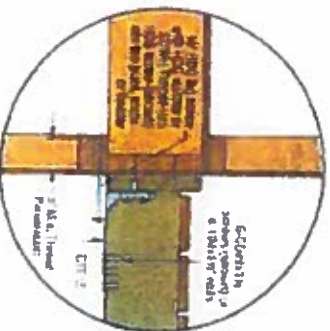

OPTION #3: FREE-STANDING DECKS
DIAGONAL BRACING

1. DIAGONAL BRACING IS REQUIRED PARALLEL TO THE BEAM AT EACH CORNER POST AND AT ALL BEAM POST LOCATIONS.
2. DIAGONAL BRACING IS PROHIBITED ON CENTER POSTS.
3. BRACING SHALL BE FASTENED TO THE POST AT ONE END AND THE BEAM AT THE OTHER WITH 1/2" DIAMETER LAG SCREWS.
4. DIAGONAL BRACING IS REQUIRED ON ALL (FREE-STANDING & LEDGER) DECKS GREATER THAN 4' ABOVE GRADE.
5. PROVIDE BLOCKING WHEN BRACING DOES NOT ALIGN WITH JOIST.

DIAGONAL BRACING

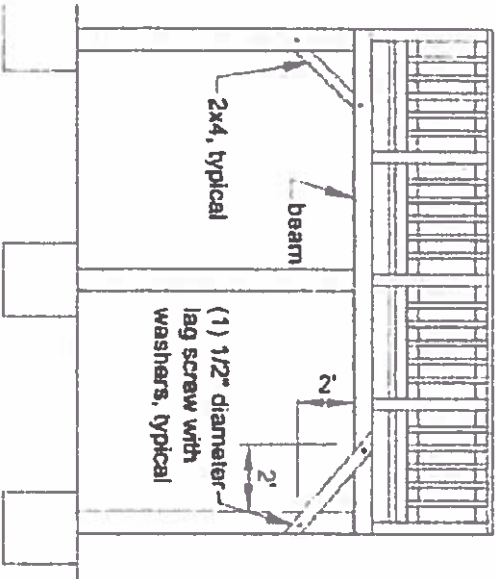

GUARD POST CONNECTION TO RIM BOARD

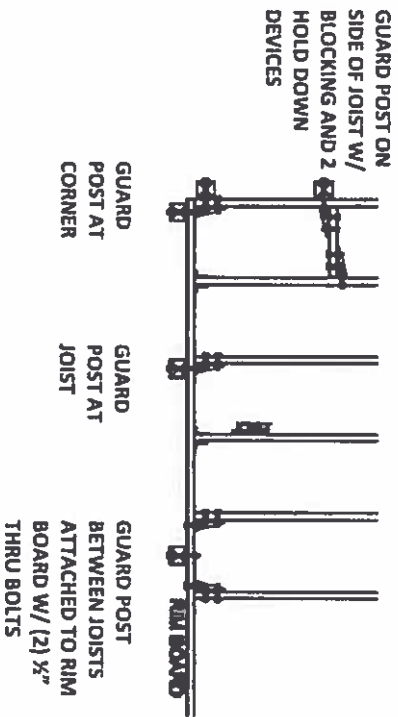
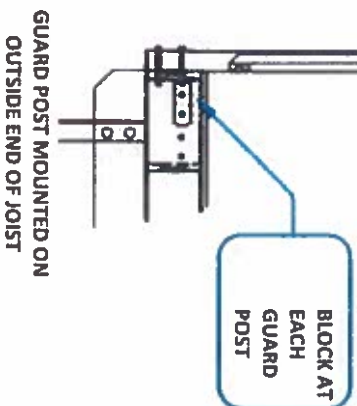
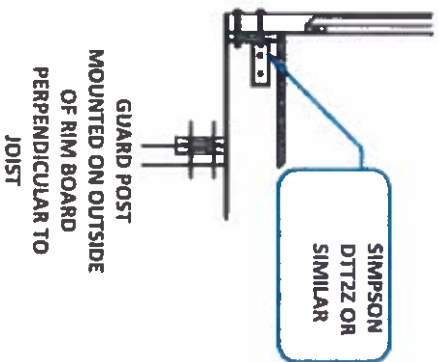

NO CARRIAGE BOLTS

STAIR AND RAMP REQUIREMENTS

STAIR RISERS

THE MAXIMUM RISER HEIGHT SHALL BE $8\frac{1}{4}$ INCHES. THE RISER SHALL BE MEASURED VERTICALLY BETWEEN THE LEADING EDGES OF THE ADJACENT TREADS. THE GREATEST RISER HEIGHT WITHIN ANY FLIGHT OF STAIRS SHALL NOT EXCEED THE SMALLEST BY MORE THAN $\frac{3}{8}$ INCH.

OPEN RISERS ARE PERMITTED PROVIDED THAT THE OPENING BETWEEN TREADS DOES NOT PERMIT THE PASSAGE OF A 4-INCH-DIAMETER SPHERE.

STAIR TREADS

THE MINIMUM TREAD DEPTH SHALL BE 9 INCHES. THE GREATEST TREAD DEPTH WITHIN ANY FLIGHT OF STAIRS SHALL NOT EXCEED THE SMALLEST BY MORE THAN $\frac{3}{8}$ INCH.

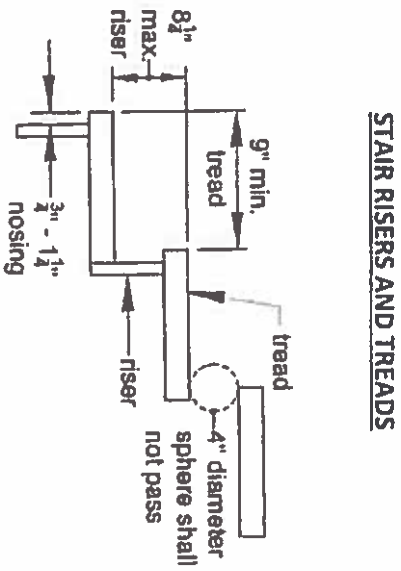

STAIR RISERS AND TREADS

STRINGERS

ALL STRINGERS SHALL BE A MINIMUM OF 2X12 P.T. MATERIAL.

IF THE STRINGER IS FABRICATED BY CUTTING NOTCHES FOR THE RISERS AND TREADS, THREE STRINGERS SHALL BE REQUIRED FOR A 36" WIDE STAIR. NOTE: DO NOT OVER CUT NOTCHES.

IF THE STRINGER IS FABRICATED FROM AN UNCUT 2X12, TWO STRINGERS ARE REQUIRED FOR A 36" WIDE STAIR.

STRINGERS SHALL NOT SPAN MORE THAN THE DIMENSIONS SHOWN, OTHERWISE AN INTERMEDIATE POST IS REQUIRED.

ALL POSTS SHALL BE SUPPORTED ON A CONCRETE FOOTING AT LEAST 12" DEEP. THE STRINGER SHALL BE ATTACHED TO THE POST WITH (2) $\frac{1}{2}$ " DIA HDG THRU BOLTS.

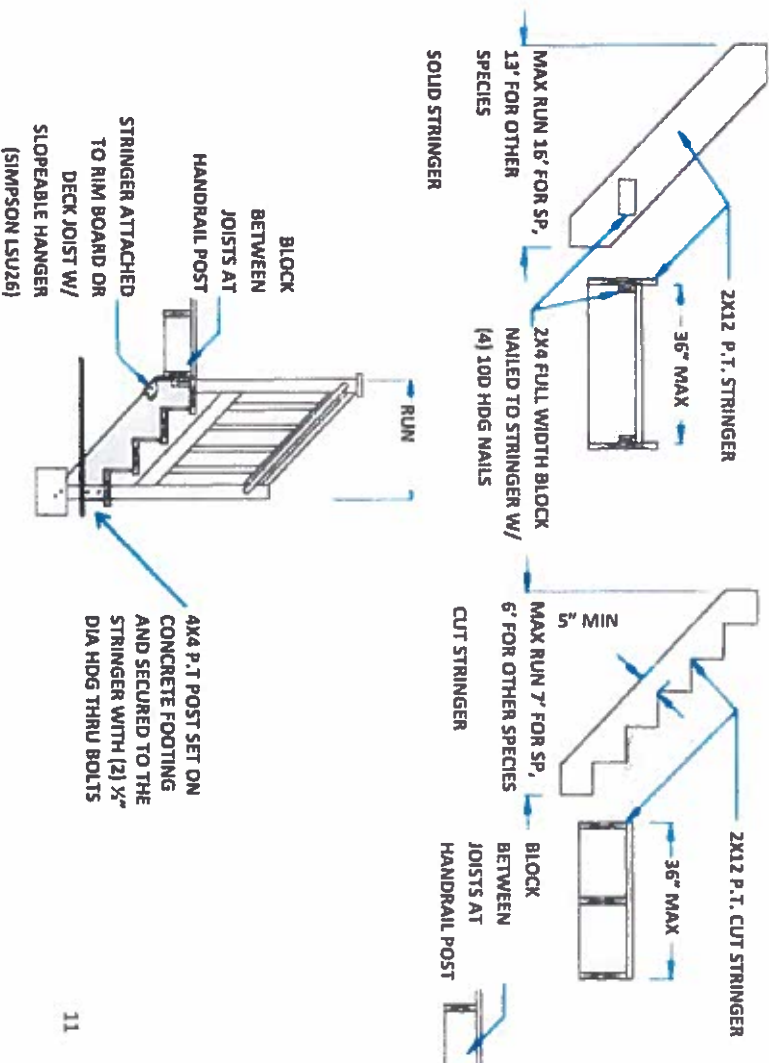

GUARD REQUIREMENTS

GUARDRAILS ARE REQUIRED WHERE THE DISTANCE FROM THE WALKING SURFACE TO GRADE IS MORE THAN 30" MEASURED OUT 36" FROM THE FACE OF THE DECK.

THE MINIMUM HEIGHT OF THE GUARDRAIL MUST BE 36".

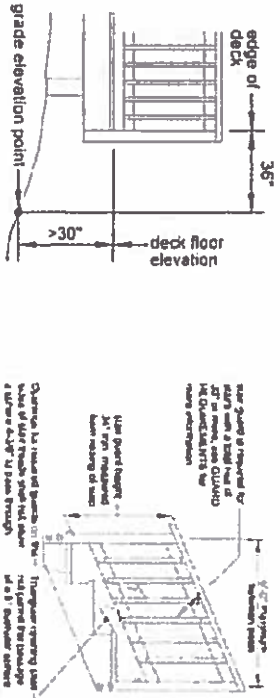

THE TOP OF THE GUARDRAIL CAP MUST BE BETWEEN 34" AND 38" WHERE MEASURED FROM THE NOSING OF THE STAIR TREAD.
 THE BOTTOM RAIL MUST BE LOCATED SO THAT A 6" SPHERE CANNOT PASS BETWEEN THE TRIANGLE FORMED BY THE RISER, TREAD AND BOTTOM RAIL.
 ALL GUARDS SHALL BE ABLE TO WITHSTAND A LOADING OF 200 LBS IN ANY DIRECTION.

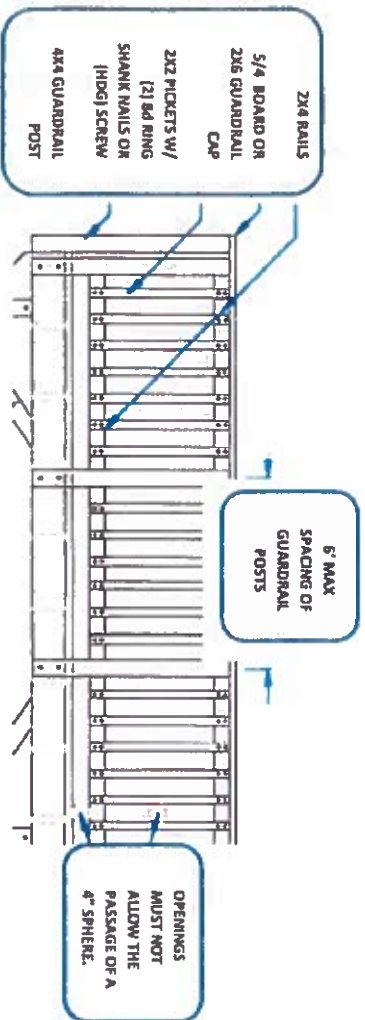

HANDRAIL REQUIREMENTS

HANDRAILS SHALL BE PROVIDED ON AT LEAST ONE SIDE OF EACH CONTINUOUS RUN OF TREADS OR FLIGHT WITH FOUR OR MORE RISERS.

HANDRAIL HEIGHT SHALL BE NOT LESS THAN 34 INCHES AND NOT MORE THAN 38 INCHES. HANDRAILS MUST RETURN TO THE WALL OR POST.

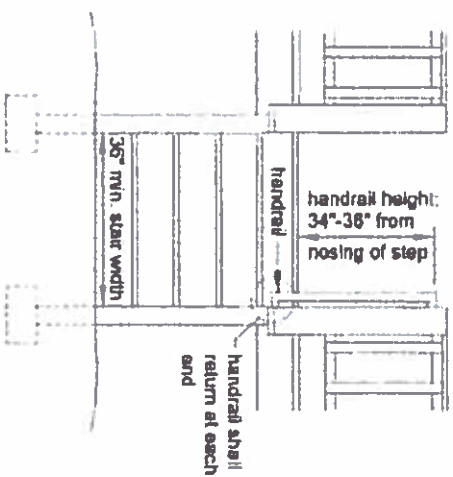

HANDRAIL PROFILES AND GRIP SIZES
 A HANDRAIL (TYPE 1 OR TYPE 2 PROFILE) IS REQUIRED ON AT LEAST ONE SIDE OF THE STAIR WHEN THERE ARE FOUR OR MORE RISERS.

TYPE 1
 HANDRAILS WITH A CIRCULAR CROSS SECTION SHALL HAVE AN OUTSIDE DIAMETER OF AT LEAST 1 1/4 INCHES AND NOT GREATER THAN 2 INCHES. IF THE HANDRAIL IS NOT CIRCULAR, IT SHALL HAVE A PERIMETER DIMENSION OF AT LEAST 4 INCHES AND NOT GREATER THAN 6 1/4 INCHES WITH A MAXIMUM CROSS SECTION OF DIMENSION OF 2 1/4 INCHES.

TYPE 2

HANDRAILS WITH A PERIMETER GREATER THAN 6 3/4 INCHES SHALL HAVE A GRASPABLE FINGER RECESS AREA ON BOTH SIDES OF THE PROFILE. THE FINGER RECESS SHALL BEGIN WITHIN A DISTANCE OF 3/4 INCH MEASURED VERTICALLY FROM THE TALLEST PORTION OF THE PROFILE AND ACHIEVE A DEPTH OF AT LEAST 3/16 INCH WITHIN 7/8 INCH BELOW THE WIDEST PORTION OF THE PROFILE. THIS REQUIRED DEPTH SHALL CONTINUE FOR AT LEAST 3/8 INCH TO A LEVEL THAT IS NOT LESS THAN 1 3/4 INCHES BELOW THE TALLEST PORTION OF THE PROFILE. THE MINIMUM WIDTH OF THE HANDRAIL ABOVE THE RECESS SHALL BE 1 1/4 INCHES TO A MAXIMUM OF 2 3/4 INCHES. EDGES SHALL HAVE A MINIMUM RADIUS OF 0.01 INCH.

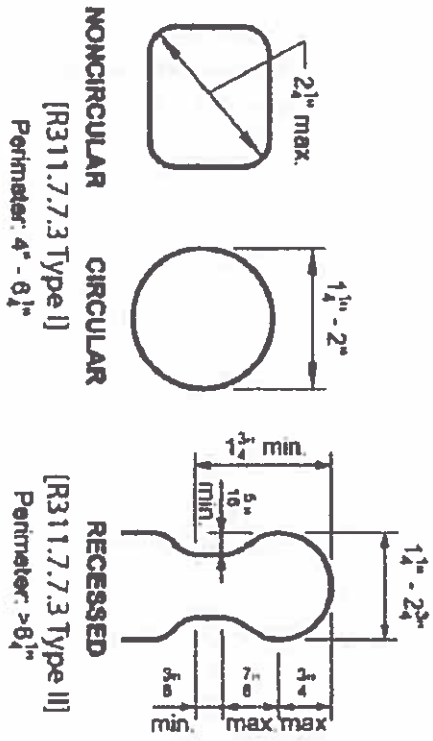

LANDINGS

WHEN A STAIRWAY EXCEEDS A VERTICAL HEIGHT OF 12', AN INTERMEDIATE LANDING SHALL BE PROVIDED. LANDINGS SHALL BE AS WIDE AS THE STAIR WIDTH IT SERVES (MIN 36").

RAMPS

RAMPS MAY BE STAIRIGHT RUNS OR "L" OR "U" SHAPED. RAMPS SHALL HAVE A MAXIMUM SLOPE OF 1:12 (THAT MEANS THAT FOR EVERY INCH IN HEIGHT THE RAMP HAS TO CLIMB, IT SHALL BE ONE FOOT LONG). WHERE IT IS TECHNICALLY INFEASIBLE BECAUSE OF SITE CONSTRAINTS THE MAXIMUM SLOPE MAY BE 1:8. WHERE RAMPS CHANGE DIRECTIONS, A LEVEL LANDING THE WIDTH OF THE RAMP IS REQUIRED.

HANDRAILS ARE REQUIRED ON AT LEAST ONE SIDE OF THE RAMP AND MAY BE ATTACHED TO THE HOUSE. GUARDRAILS ARE REQUIRED WHERE THE HEIGHT OF THE RAMP ABOVE GRADE EXCEEDS 30".

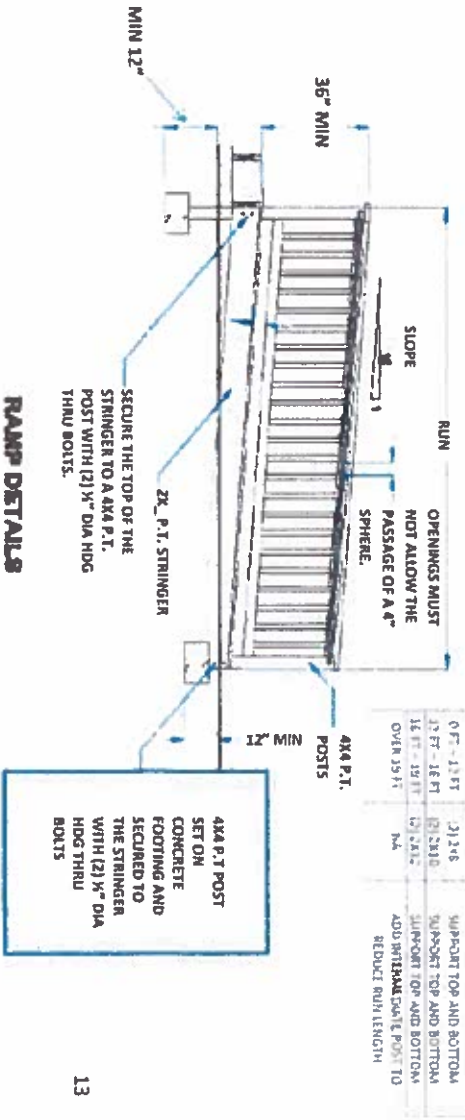

RUN (LENGTH)	MATERIAL	NUMBER OF SUPPORTS
0 FT - 21 FT	(2) 2x6	SUPPORT TOP AND BOTTOM
21 FT - 36 FT	(2) 2x6	SUPPORT TOP AND BOTTOM
36 FT - 49 FT	(2) 2x6	SUPPORT TOP AND BOTTOM
OVER 49 FT	NA	ADD INTERMEDIATE POSTS TO REDUCE RUN LENGTH

STAIRWAY ILLUMINATION

ALL EXTERIOR STAIRWAYS SHALL BE PROVIDED WITH A MEANS TO ILLUMINATE THE STAIRS, INCLUDING THE LANDINGS AND TREADS.

EXTERIOR STAIRWAYS SHALL BE PROVIDED WITH AN ARTIFICIAL LIGHT SOURCE LOCATED IN THE IMMEDIATE VICINITY OF THE TOP LANDING OF THE STAIRWAY.

GLAZING

WINDOWS

GLAZING IN AN INDIVIDUAL FIXED OR OPERABLE PANEL THAT MEETS ALL OF THE FOLLOWING CONDITIONS SHALL BE CONSIDERED A HAZARDOUS LOCATION:

1. THE EXPOSED AREA OF AN INDIVIDUAL PANE IS LARGER THAN 9 SQUARE FEET
2. THE BOTTOM EDGE OF THE GLAZING IS LESS THAN 18 INCHES ABOVE THE FLOOR
3. THE TOP EDGE OF THE GLAZING IS MORE THAN 36 INCHES ABOVE THE FLOOR; AND
4. ONE OR MORE WALKING SURFACES ARE WITHIN 36 INCHES, MEASURED HORIZONTALLY AND IN A STRAIGHT LINE, OF THE GLAZING.

EXCEPTIONS:

1. DECORATIVE GLAZING.
2. WHEN A HORIZONTAL RAIL IS INSTALLED ON THE ACCESSIBLE SIDE(S) OF THE GLAZING 34 TO 38 INCHES ABOVE THE WALKING SURFACE. THE RAIL SHALL BE CAPABLE OF WITHSTANDING A HORIZONTAL LOAD OF 50 POUNDS PER LINEAR FOOT WITHOUT CONTACTING THE GLASS AND BE A MINIMUM OF 1 1/2 INCHES IN CROSS SECTIONAL HEIGHT.
3. OUTBOARD PANES IN INSULATING GLASS UNITS AND OTHER MULTIPLE GLAZED PANELS WHEN THE BOTTOM EDGE OF THE GLASS IS 25 FEET OR MORE ABOVE GRADE, A ROOF, WALKING SURFACES OR OTHER HORIZONTAL [WITHIN 45 DEGREES (0.79 RAD) OF HORIZONTAL] SURFACE ADJACENT TO THE GLASS EXTERIOR.

GUARDS AND RAILINGS

GLAZING IN GUARDS AND RAILINGS, INCLUDING STRUCTURAL BALUSTER PANELS AND NONSTRUCTURAL IN-FILL PANELS, REGARDLESS OF AREA OR HEIGHT ABOVE A WALKING SURFACE SHALL BE CONSIDERED A HAZARDOUS LOCATION.

ADJACENT STAIRS AND RAMPS

GLAZING WHERE THE BOTTOM EXPOSED EDGE OF THE GLAZING IS LESS THAN 36 INCHES ABOVE THE PLANE OF THE ADJACENT WALKING SURFACE OF STAIRWAYS, LANDINGS BETWEEN FLIGHTS OF STAIRS AND RAMPS SHALL BE CONSIDERED A HAZARDOUS LOCATION.

EXCEPTIONS:

1. WHEN A RAIL IS INSTALLED ON THE ACCESSIBLE SIDE(S) OF THE GLAZING 34 TO 38 INCHES ABOVE THE WALKING SURFACE. THE RAIL SHALL BE CAPABLE OF WITHSTANDING A HORIZONTAL LOAD OF 50 POUNDS PER LINEAR FOOT WITHOUT CONTACTING THE GLASS AND BE A MINIMUM OF 1 1/2 INCHES IN CROSS SECTIONAL HEIGHT.
2. GLAZING 36 INCHES OR MORE MEASURED HORIZONTALLY FROM THE WALKING SURFACE.

ADJACENT TO THE BOTTOM STAIR LANDING

GLAZING ADJACENT TO THE LANDING AT THE BOTTOM OF A STAIRWAY WHERE THE GLAZING IS LESS THAN 36 INCHES ABOVE THE LANDING AND WITHIN 60 INCHES HORIZONTALLY OF THE BOTTOM TREAD SHALL BE CONSIDERED A HAZARDOUS LOCATION.

EXCEPTION: THE GLAZING IS PROTECTED BY A GUARD COMPLYING WITH SECTION R312 AND THE PLANE OF THE GLASS IS MORE THAN 18 INCHES FROM THE GUARDS.

